

Gamme EVO insertion dans cloison de distribution 72

Descriptif:

Cloison à ossature aluminium alliage 6060T6.

Equerre de liaison en acier traité et maintien des vitrages par clips ressort.

Largeur cloison 80 mm, largeur habillage 40 mm.

Création de chassie vitrée ou de bloc porte aluminium dans cloison de distribution.

Finitions:

Laqué dans la gamme RAL ou Anodisé.

Remplissages:

Simple ou double vitrage 6 ou 8 mm.

Portes:

Porte bois épaisseur 40 mm

Porte à cadre aluminium épaisseur 40 mm

Porte Clarite

Siège social: 3 route de Bichailloux
19 ZA Croix Saint Mathieu
28320 Gallardon
France

Téléphone: +33 6 78 87 57 37
Mail: info@sact.fr
Site internet: www.sact.fr

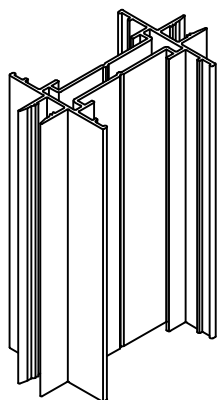

Poteau
ref: EVO150

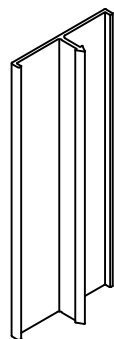

Habillage
ref: EVO155

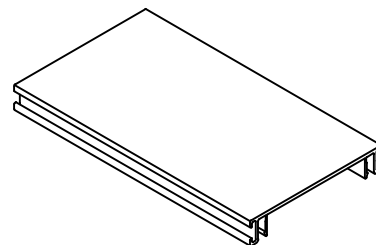

Carter double vitrage
ref: EVO219

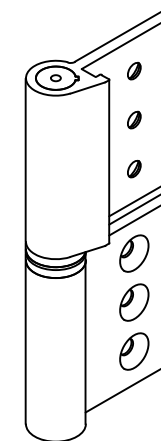

Paumelle
ref: AC10

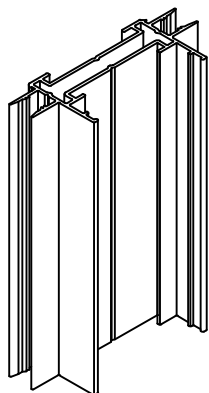

Demi poteau
ref: EVO151

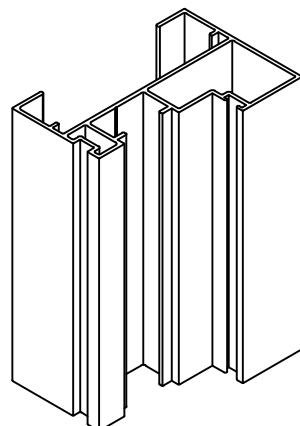

Huisserie
ref: EVO400

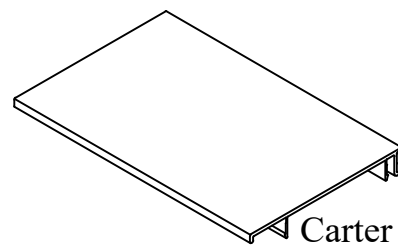

Carter simple vitrage
ref: EVO220



Clips
ref: AC01

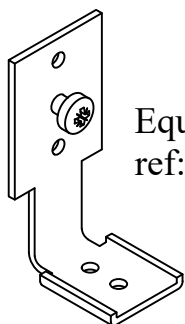

Equerre d'assemblage
ref: AC40

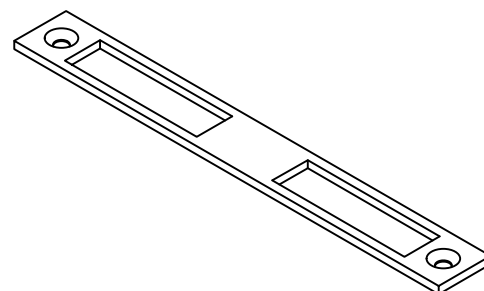

Gâche Inox
ref: AC15

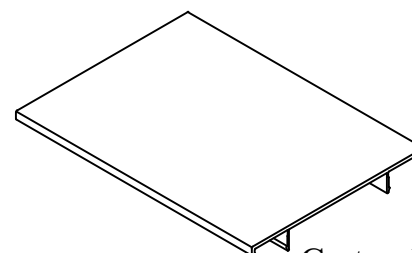

Carter de finition
ref: EVO221

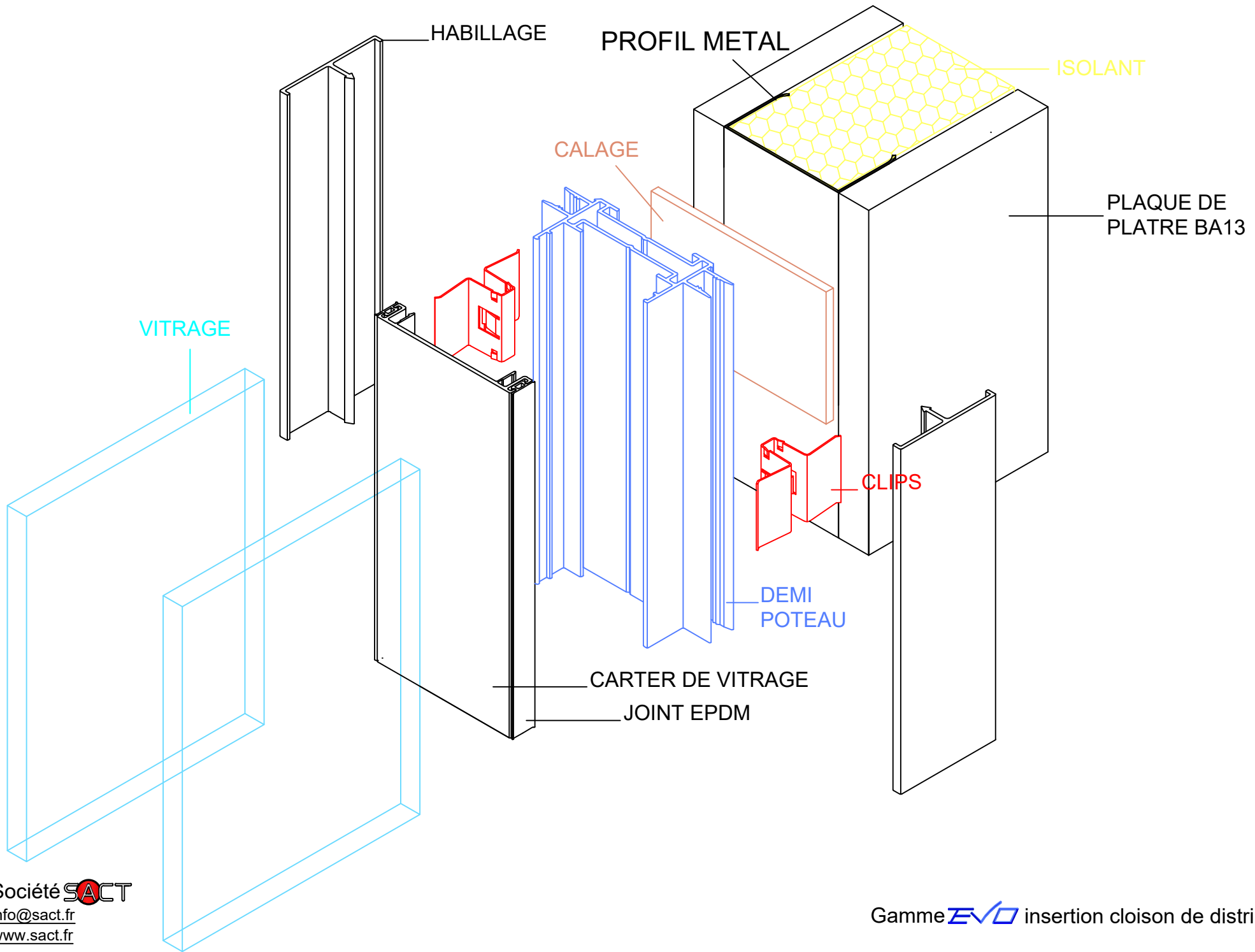

INSERTION DE MODULES VITRES DANS CLOISONS DE DISTRIBUTION 72/48 PAREMENTS SIMPLES BA13

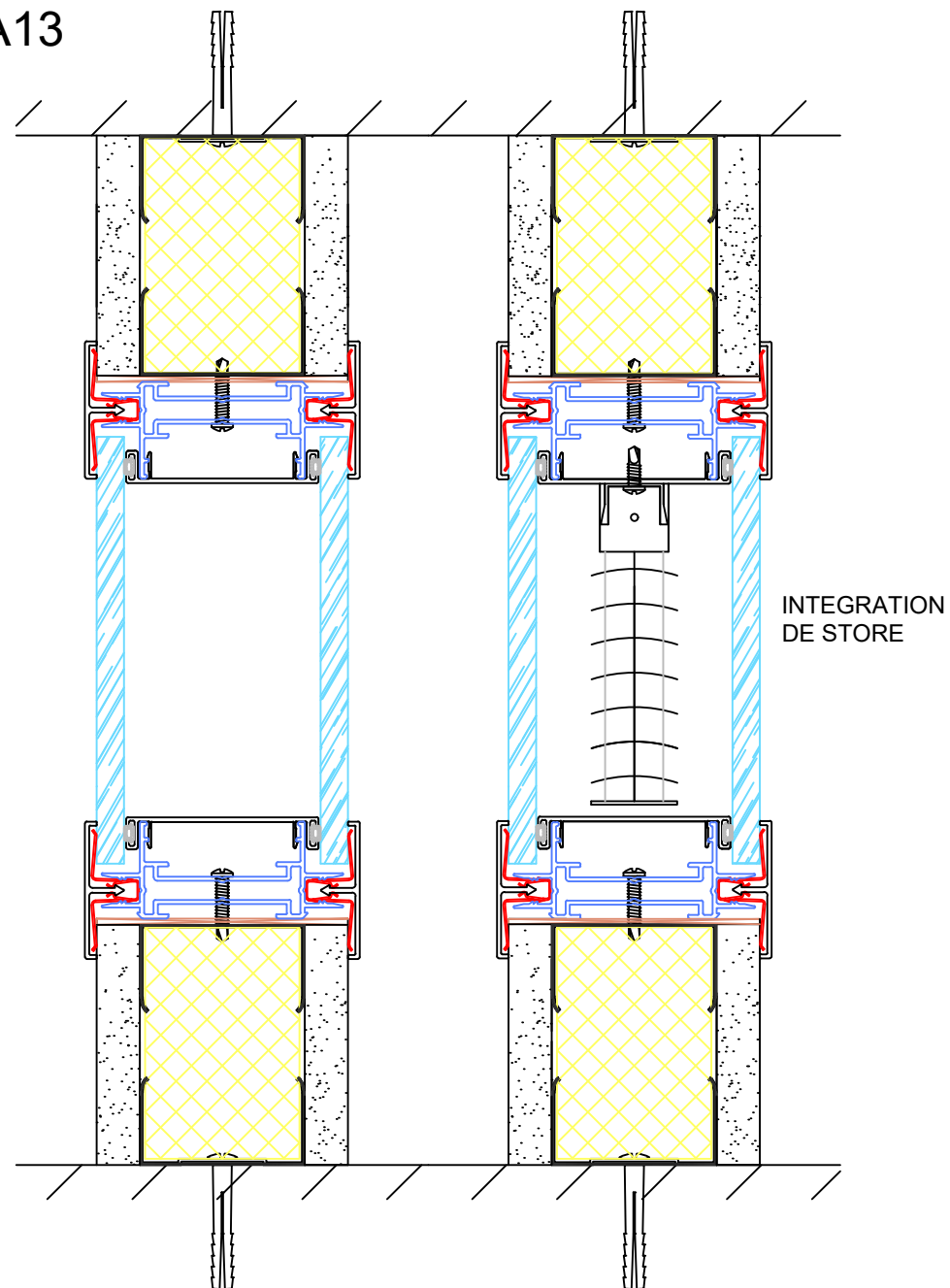
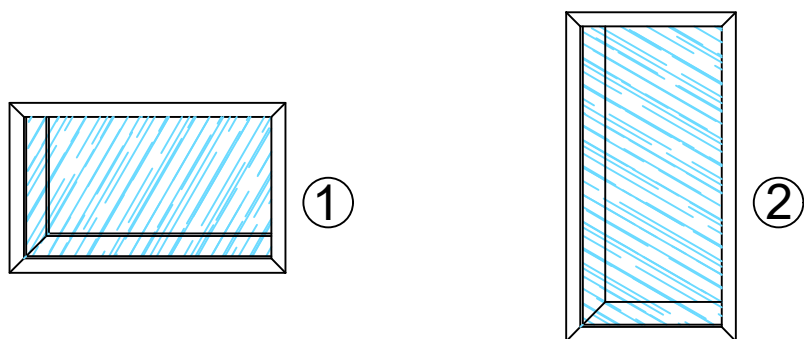
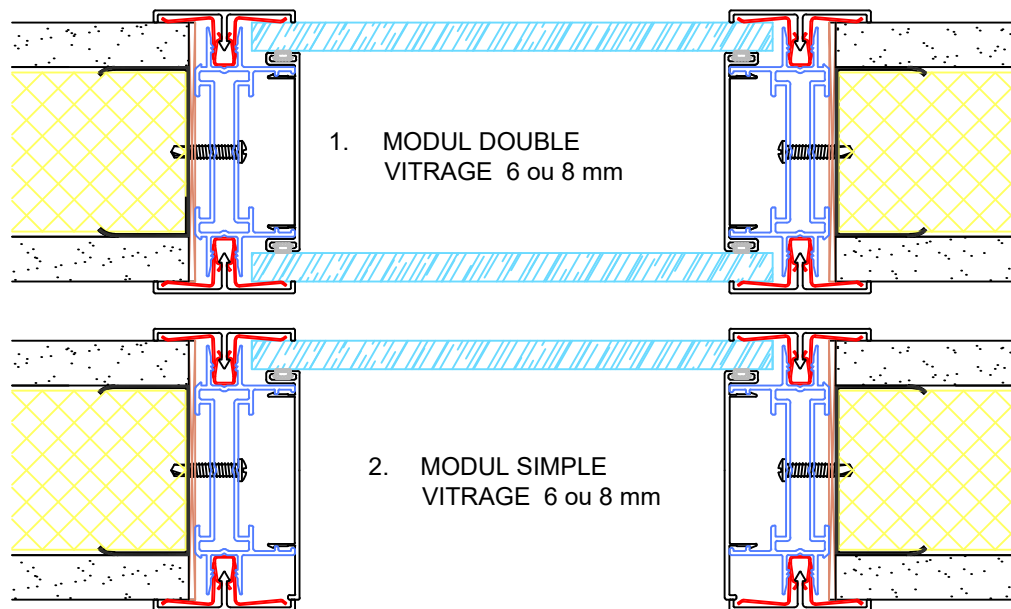

INSERTION DE BLOC PORTE DANS CLOISONS DE DISTRIBUTION 72/48 PAREMENTS SIMPLES BA13

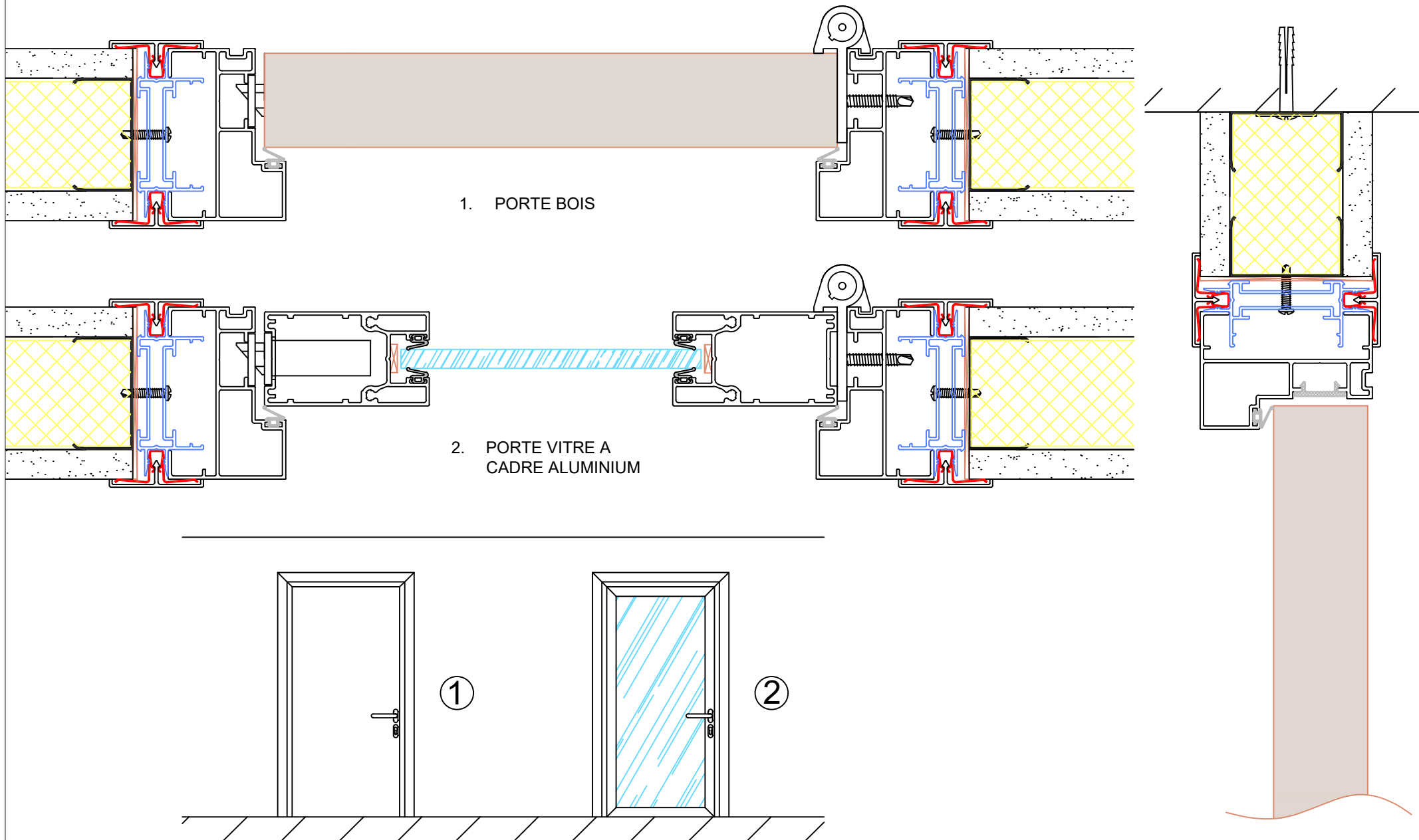

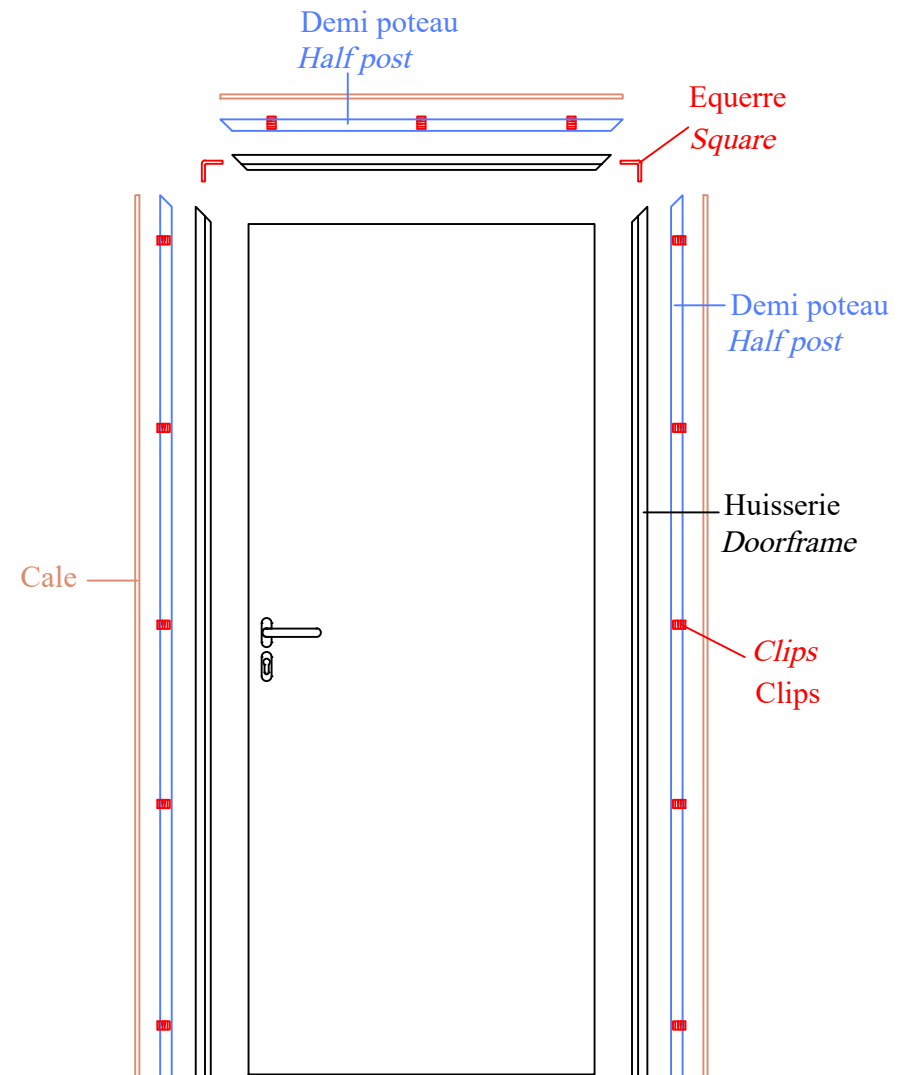
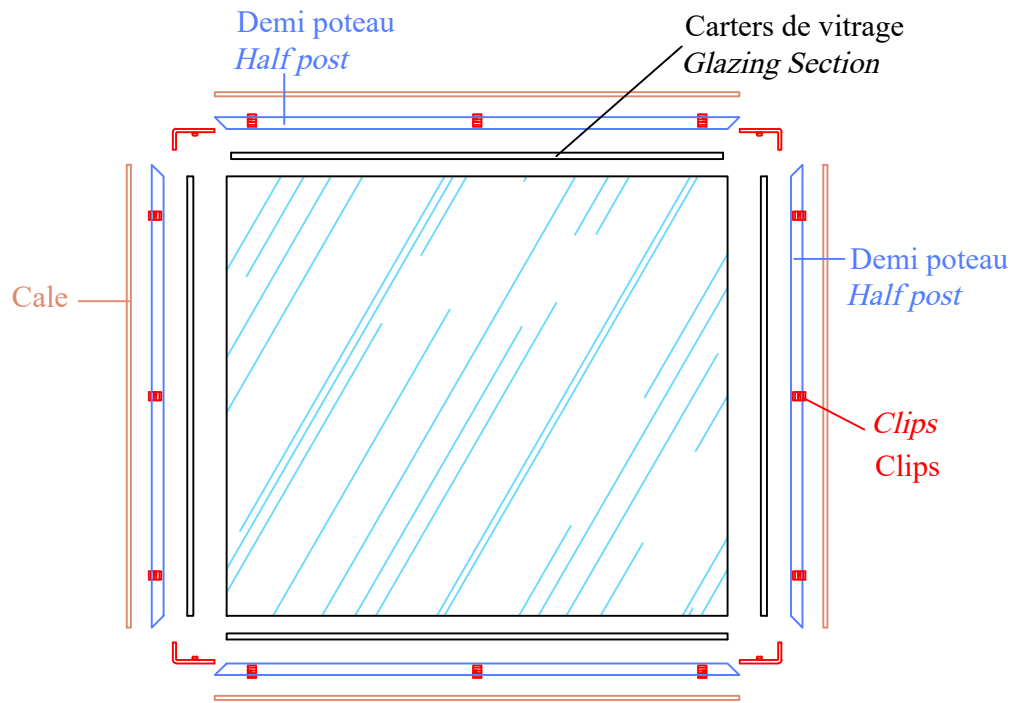

Distance entre clips environs 600 mm
Distance between clips surroundings 600 mm